

Replacement parts suitable for PRIMA INDUSTRIE[®]

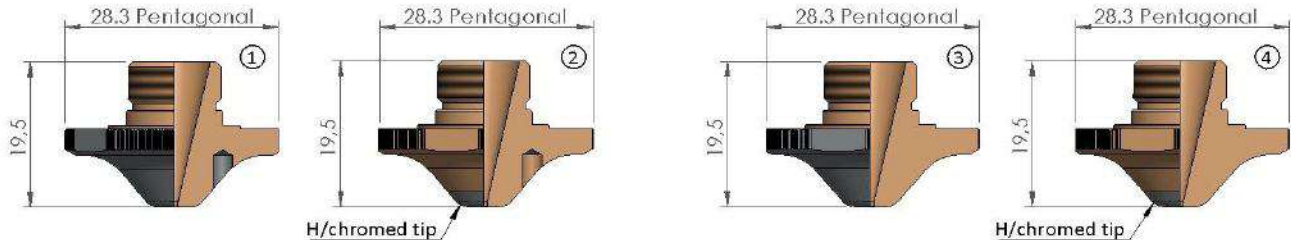

POS	LS. CODE	ORIGINAL CODE	DESCRIPTION
1	253014C	LW6.1G.660	PRIMA I. [®] NOZZLE PENT Ø 0.8 CP
	253015C	LW6.1G.661	PRIMA I. [®] NOZZLE PENT Ø 1.0 CP
	253016C	LW6.1G.662	PRIMA I. [®] NOZZLE PENT Ø 1.25 CP
	253017C	LW6.1G.663	PRIMA I. [®] NOZZLE PENT Ø 1.5 CP
	253018C	LW6.1G.664	PRIMA I. [®] NOZZLE PENT Ø 1.75 CP
	253019C	LW6.1G.665	PRIMA I. [®] NOZZLE PENT Ø 2.0 CP
	253020C	LW6.1G.667	PRIMA I. [®] NOZZLE PENT Ø 2.5 CP
	253021C	LW6.1G.669	PRIMA I. [®] NOZZLE PENT Ø 3.0 CP
	253022C	LW6.1G.670	PRIMA I. [®] NOZZLE PENT Ø 3.5 CP
	253023C	LW6.1G.666	PRIMA I. [®] NOZZLE PENT Ø 2.25 CP
	253024C	LW6.1G.668	PRIMA I. [®] NOZZLE PENT Ø 2.75 CP
	2	253014CK	LW6.1G.660
253015CK		LW6.1G.661	PRIMA I. [®] NOZZLE PENT Ø 1.0 CP
253016CK		LW6.1G.662	PRIMA I. [®] NOZZLE PENT Ø 1.25 CP
253017CK		LW6.1G.663	PRIMA I. [®] NOZZLE PENT Ø 1.5 CP
253018CK		LW6.1G.664	PRIMA I. [®] NOZZLE PENT Ø 1.75 CP
253019CK		LW6.1G.665	PRIMA I. [®] NOZZLE PENT Ø 2.0 CP
253020CK		LW6.1G.667	PRIMA I. [®] NOZZLE PENT Ø 2.5 CP
253021CK		LW6.1G.669	PRIMA I. [®] NOZZLE PENT Ø 3.0 CP
253022CK		LW6.1G.670	PRIMA I. [®] NOZZLE PENT Ø 3.5 CP
253023CK		LW6.1G.666	PRIMA I. [®] NOZZLE PENT Ø 2.25 CP
253024CK		LW6.1G.668	PRIMA I. [®] NOZZLE PENT Ø 2.75 CP
3		253031C	LW6.1G.121
	253025C	LW6.1G.103	PRIMA I. [®] NOZZLE PENT Ø 1.5 CP
	253026C	LW6.1G.105	PRIMA I. [®] NOZZLE PENT Ø 2.0 CP
	253027C	LW6.1G.107	PRIMA I. [®] NOZZLE PENT Ø 2.5 CP
	253028C	LW6.1G.109	PRIMA I. [®] NOZZLE PENT Ø 3.0 CP
	4	253031CK	LW6.1G.121
253025CK		LW6.1G.103	PRIMA I. [®] NOZZLE PENT Ø 1.5 CP
253026CK		LW6.1G.105	PRIMA I. [®] NOZZLE PENT Ø 2.0 CP
253027CK		LW6.1G.107	PRIMA I. [®] NOZZLE PENT Ø 2.5 CP
253028CK		LW6.1G.109	PRIMA I. [®] NOZZLE PENT Ø 3.0 CP

Replacement parts suitable for PRIMA INDUSTRIE[®]

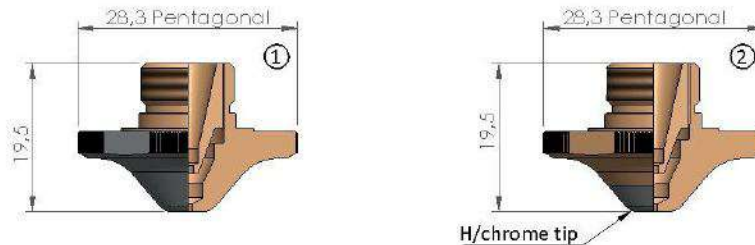

POS	LS. CODE	ORIGINAL CODE	DESCRIPTION
1	253033C	LW6.1G.302	PRIMA I. [®] DOUBLE NOZZLE PENT Ø 1.25 CP
	253034C	LW6.1G.303	PRIMA I. [®] DOUBLE NOZZLE PENT Ø 1.5 CP
	253035C	LW6.1G.304	PRIMA I. [®] DOUBLE NOZZLE PENT Ø 1.75 CP
	253036C	LW6.1G.305	PRIMA I. [®] DOUBLE NOZZLE PENT Ø 2.0 CP
	253037C	LW6.1G.307	PRIMA I. [®] DOUBLE NOZZLE PENT Ø 2.5 CP
	253038C	LW6.1E.204	PRIMA I. [®] DOUBLE NOZZLE PENT Ø 2.5 CP
	253039C	LW6.1G.309	PRIMA I. [®] DOUBLE NOZZLE PENT Ø 3.0 CP
	253040C	LW6.1E.206	PRIMA I. [®] DOUBLE NOZZLE PENT Ø 3.0 CP
	253041C	LW6.1E.207	PRIMA I. [®] DOUBLE NOZZLE PENT Ø 3.5 CP
2	253033CK	LW6.1G.302	PRIMA I. [®] DOUBLE NOZZLE PENT Ø 1.25 CP
	253034CK	LW6.1G.303	PRIMA I. [®] DOUBLE NOZZLE PENT Ø 1.5 CP
	253035CK	LW6.1G.304	PRIMA I. [®] DOUBLE NOZZLE PENT Ø 1.75 CP
	253036CK	LW6.1G.305	PRIMA I. [®] DOUBLE NOZZLE PENT Ø 2.0 CP
	253037CK	LW6.1G.307	PRIMA I. [®] DOUBLE NOZZLE PENT Ø 2.5 CP
	253038CK	LW6.1E.204	PRIMA I. [®] DOUBLE NOZZLE PENT Ø 2.5 CP
	253039CK	LW6.1G.309	PRIMA I. [®] DOUBLE NOZZLE PENT Ø 3.0 CP
	253040CK	LW6.1E.206	PRIMA I. [®] DOUBLE NOZZLE PENT Ø 3.0 CP
	253041CK	LW6.1E.207	PRIMA I. [®] DOUBLE NOZZLE PENT Ø 3.5 CP

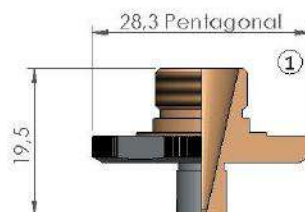

POS	LS. CODE	ORIGINAL CODE	DESCRIPTION
1	253045C	LW6.1G.699	PRIMA I. [®] NOZZLE PENT Ø 1.5 CP
	253046C	LW6.1G.700	PRIMA I. [®] NOZZLE PENT Ø 2.0 CP
	253047C	LW6.1G.701	PRIMA I. [®] NOZZLE PENT Ø 2.5 CP
	253048C	LW6.1G.702	PRIMA I. [®] NOZZLE PENT Ø 3.0 CP

Replacement parts suitable for PRIMA INDUSTRIE[®]



POS	LS. CODE	ORIGINAL CODE	DESCRIPTION
1	253050	LW6.1G.200	PRIMA I. [®] DOUBLE NOZZLE PENT Ø 3.0
	253051	LW6.1G.201	PRIMA I. [®] DOUBLE NOZZLE PENT Ø 3.5
	253052	LW6.1G.202	PRIMA I. [®] DOUBLE NOZZLE PENT Ø 4.0
2	253053	LW6.1G.203	PRIMA I. [®] DOUBLE NOZZLE PENT Ø 5.0
3	253054	LW6.1G.204	PRIMA I. [®] DOUBLE NOZZLE PENT Ø 7.0

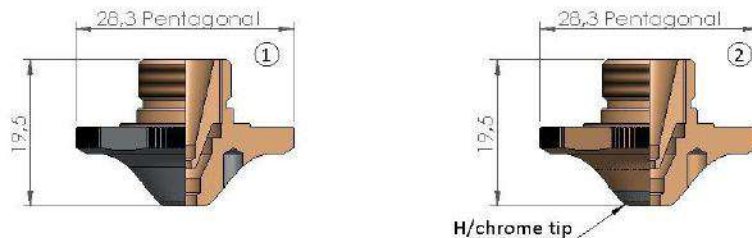

POS	LS. CODE	ORIGINAL CODE	DESCRIPTION
1	253060C	LW6.1G.680	PRIMA I. [®] DOUBLE NOZZLE PENT Ø 0.8 CP
	253061C	LW6.1G.681	PRIMA I. [®] DOUBLE NOZZLE PENT Ø 1.0 CP
	253062C	LW6.1G.682	PRIMA I. [®] DOUBLE NOZZLE PENT Ø 1.25 CP
	253063C	LW6.1G.683	PRIMA I. [®] DOUBLE NOZZLE PENT Ø 1.5 CP
	253064C	LW6.1G.684	PRIMA I. [®] DOUBLE NOZZLE PENT Ø 1.75 CP
	253065C	LW6.1G.685	PRIMA I. [®] DOUBLE NOZZLE PENT Ø 2.0 CP
	253066C	LW6.1G.686	PRIMA I. [®] DOUBLE NOZZLE PENT Ø 2.25 CP
	253067C	LW6.1G.687	PRIMA I. [®] DOUBLE NOZZLE PENT Ø 2.5 CP
	253068C	LW6.1G.688	PRIMA I. [®] DOUBLE NOZZLE PENT Ø 2.75 CP
	253069C	LW6.1G.689	PRIMA I. [®] DOUBLE NOZZLE PENT Ø 3.0 CP
2	253060CK	LW6.1G.680	PRIMA I. [®] DOUBLE NOZZLE PENT Ø 0.8 CP
	253061CK	LW6.1G.681	PRIMA I. [®] DOUBLE NOZZLE PENT Ø 1.0 CP
	253062CK	LW6.1G.682	PRIMA I. [®] DOUBLE NOZZLE PENT Ø 1.25 CP
	253063CK	LW6.1G.683	PRIMA I. [®] DOUBLE NOZZLE PENT Ø 1.5 CP
	253064CK	LW6.1G.684	PRIMA I. [®] DOUBLE NOZZLE PENT Ø 1.75 CP
	253065CK	LW6.1G.685	PRIMA I. [®] DOUBLE NOZZLE PENT Ø 2.0 CP
	253066CK	LW6.1G.686	PRIMA I. [®] DOUBLE NOZZLE PENT Ø 2.25 CP
	253067CK	LW6.1G.687	PRIMA I. [®] DOUBLE NOZZLE PENT Ø 2.5 CP
	253068CK	LW6.1G.688	PRIMA I. [®] DOUBLE NOZZLE PENT Ø 2.75 CP
	253069CK	LW6.1G.689	PRIMA I. [®] DOUBLE NOZZLE PENT Ø 3.0 CP

Replacement parts suitable for PRIMA INDUSTRIE[®]

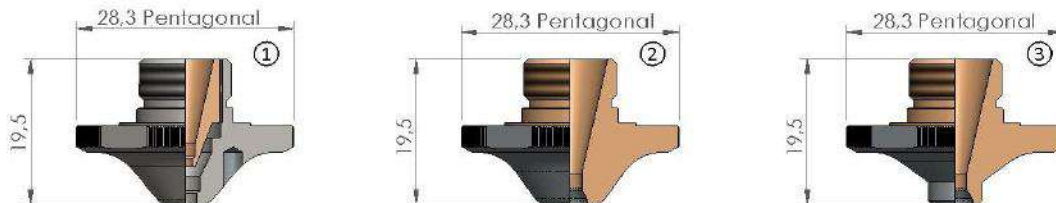

POS	LS. CODE	ORIGINAL CODE	DESCRIPTION
1	253074	LW6.1G.800	PRIMA I. [®] DOUBLE NOZZLE PENT Ø 3.0
	253075	LW6.1G.801	PRIMA I. [®] DOUBLE NOZZLE PENT Ø 3.5
	253076	LW6.1G.802	PRIMA I. [®] DOUBLE NOZZLE PENT Ø 4.0
	253077	LW6.1G.803	PRIMA I. [®] DOUBLE NOZZLE PENT Ø 5.0
	253078	LW6.1G.804	PRIMA I. [®] DOUBLE NOZZLE PENT Ø 7.0
2	253080C	LW6.1G.522a	PRIMA I. [®] NOZZLE PENT Ø 3.0 CP
3	253085C	LW6.1G.524	PRIMA I. [®] NOZZLE PENT Ø 3.0 CP

Replacement parts suitable for PRIMA INDUSTRIE[®]

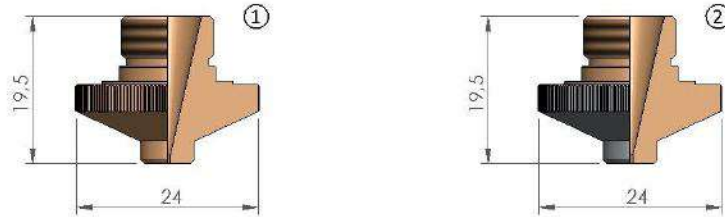

POS	LS. CODE	ORIGINAL CODE	DESCRIPTION
1	251002		PRIMA I. [®] NOZZLE Ø 0.8
	251002W		PRIMA I. [®] NOZZLE Ø 0.8
	251003		PRIMA I. [®] NOZZLE Ø 1.0
	251003W		PRIMA I. [®] NOZZLE Ø 1.0
	251004		PRIMA I. [®] NOZZLE Ø 1.2
	251004W		PRIMA I. [®] NOZZLE Ø 1.2
	251005	LW6.1E.111	PRIMA I. [®] NOZZLE Ø 1.5
	251005W	LW6.1E.111	PRIMA I. [®] NOZZLE Ø 1.5
	251006	LW6.1E.112	PRIMA I. [®] NOZZLE Ø 2.0
	251006W	LW6.1E.112	PRIMA I. [®] NOZZLE Ø 2.0
	251007	LW6.1E.113	PRIMA I. [®] NOZZLE Ø 2.5
	251007W	LW6.1E.113	PRIMA I. [®] NOZZLE Ø 2.5
	251008	LW6.1E.114	PRIMA I. [®] NOZZLE Ø 3.0
	251008W	LW6.1E.114	PRIMA I. [®] NOZZLE Ø 3.0
2	251002C		PRIMA I. [®] NOZZLE Ø 0.8 CP
	251002CW		PRIMA I. [®] NOZZLE Ø 0.8 CP
	251003C		PRIMA I. [®] NOZZLE Ø 1.0 CP
	251003CW		PRIMA I. [®] NOZZLE Ø 1.0 CP
	251004C		PRIMA I. [®] NOZZLE Ø 1.2 CP
	251004CW		PRIMA I. [®] NOZZLE Ø 1.2 CP
	251005C	LW6.1E.111	PRIMA I. [®] NOZZLE Ø 1.5 CP
	251005CW	LW6.1E.111	PRIMA I. [®] NOZZLE Ø 1.5 CP
	251006C	LW6.1E.112	PRIMA I. [®] NOZZLE Ø 2.0 CP
	251006CW	LW6.1E.112	PRIMA I. [®] NOZZLE Ø 2.0 CP
	251007C	LW6.1E.113	PRIMA I. [®] NOZZLE Ø 2.5 CP
	251007CW	LW6.1E.113	PRIMA I. [®] NOZZLE Ø 2.5 CP
	251008C	LW6.1E.114	PRIMA I. [®] NOZZLE Ø 3.0 CP
	251008CW	LW6.1E.114	PRIMA I. [®] NOZZLE Ø 3.0 CP

Replacement parts suitable for PRIMA INDUSTRIE[®]

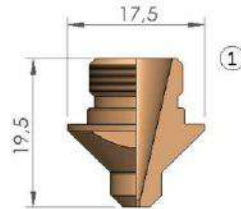

POS	LS. CODE	ORIGINAL CODE	DESCRIPTION
1	255001	750.42.559	PRIMA I. [®] NOZZLE Ø 0.3
	255001W	750.42.559	PRIMA I. [®] NOZZLE Ø 0.3
	255002		PRIMA I. [®] NOZZLE Ø 1.0
	255002W		PRIMA I. [®] NOZZLE Ø 1.0
	255003	750.42.550	PRIMA I. [®] NOZZLE Ø 1.5
	255003W	750.42.550	PRIMA I. [®] NOZZLE Ø 1.5
	255004	750.42.551	PRIMA I. [®] NOZZLE Ø 2.0
	255004W	750.42.551	PRIMA I. [®] NOZZLE Ø 2.0
	255005	750.42.552	PRIMA I. [®] NOZZLE Ø 2.5
	255005W	750.42.552	PRIMA I. [®] NOZZLE Ø 2.5
	255006	750.42.553	PRIMA I. [®] NOZZLE Ø 3.0
	255006W	750.42.553	PRIMA I. [®] NOZZLE Ø 3.0

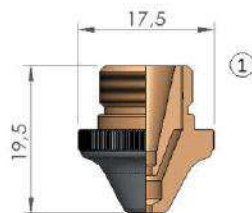

POS	LS. CODE	ORIGINAL CODE	DESCRIPTION
1	255012C	520.17.111	PRIMA I. [®] DOUBLE NOZZLE Ø 1.5 CP
	255012CW	520.17.111	PRIMA I. [®] DOUBLE NOZZLE Ø 1.5 CP
	255013C	520.17.114	PRIMA I. [®] DOUBLE NOZZLE Ø 2.0 CP
	255013CW	520.17.114	PRIMA I. [®] DOUBLE NOZZLE Ø 2.0 CP
	255014C	750.43.560	PRIMA I. [®] DOUBLE NOZZLE Ø 2.5 CP
	255014CW	750.43.560	PRIMA I. [®] DOUBLE NOZZLE Ø 2.5 CP
	255015C	520.17.561	PRIMA I. [®] DOUBLE NOZZLE Ø 3.0 CP
	255015CW	520.17.561	PRIMA I. [®] DOUBLE NOZZLE Ø 3.0 CP
	255016C	520.17.562	PRIMA I. [®] DOUBLE NOZZLE Ø 3.5 CP
	255016CW	520.17.562	PRIMA I. [®] DOUBLE NOZZLE Ø 3.5 CP

Laser Store srl is not affiliated with the named manufacturers. Reference to machines, parts, descriptions, and model numbers are for convenience in verifying compatibility only. All parts are made by or for Laser Store srl and are not made by the reference manufacturers (unless expressly indicated). All other trademarks are the properties of their respective owners."

Replacement parts suitable for PRIMA INDUSTRIE[®]

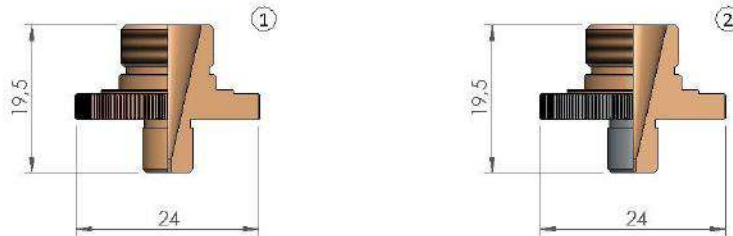

POS	LS. CODE	ORIGINAL CODE	DESCRIPTION
1	251013		PRIMA I. [®] NOZZLE Ø 1.0
	251013W		PRIMA I. [®] NOZZLE Ø 1.0
	251014		PRIMA I. [®] NOZZLE Ø 1.2
	251014W		PRIMA I. [®] NOZZLE Ø 1.2
	251015	LW6.1G.500-LW6.1G.600	PRIMA I. [®] NOZZLE Ø 1.5
	251015W	LW6.1G.500-LW6.1G.600	PRIMA I. [®] NOZZLE Ø 1.5
	251016	LW6.1G.501-LW6.1G.601	PRIMA I. [®] NOZZLE Ø 2.0
	251016W	LW6.1G.501-LW6.1G.601	PRIMA I. [®] NOZZLE Ø 2.0
	251017	LW6.1G.502-LW6.1G.602	PRIMA I. [®] NOZZLE Ø 2.5
	251017W	LW6.1G.502-LW6.1G.602	PRIMA I. [®] NOZZLE Ø 2.5
	251018	LW6.1G.503-LW6.1G.603	PRIMA I. [®] NOZZLE Ø 3.0
	251018W	LW6.1G.503-LW6.1G.603	PRIMA I. [®] NOZZLE Ø 3.0
2	251013C		PRIMA I. [®] NOZZLE Ø 1.0 CP
	251013CW		PRIMA I. [®] NOZZLE Ø 1.0 CP
	251014C		PRIMA I. [®] NOZZLE Ø 1.2 CP
	251014CW		PRIMA I. [®] NOZZLE Ø 1.2 CP
	251015C	LW6.1G.500-LW6.1G.600	PRIMA I. [®] NOZZLE Ø 1.5 CP
	251015CW	LW6.1G.500-LW6.1G.600	PRIMA I. [®] NOZZLE Ø 1.5 CP
	251016C	LW6.1G.501-LW6.1G.601	PRIMA I. [®] NOZZLE Ø 2.0 CP
	251016CW	LW6.1G.501-LW6.1G.601	PRIMA I. [®] NOZZLE Ø 2.0 CP
	251017C	LW6.1G.502-LW6.1G.602	PRIMA I. [®] NOZZLE Ø 2.5 CP
	251017CW	LW6.1G.502-LW6.1G.602	PRIMA I. [®] NOZZLE Ø 2.5 CP
	251018C	LW6.1G.503-LW6.1G.603	PRIMA I. [®] NOZZLE Ø 3.0 CP
	251018CW	LW6.1G.503-LW6.1G.603	PRIMA I. [®] NOZZLE Ø 3.0 CP

Replacement parts suitable for PRIMA INDUSTRIE[®]

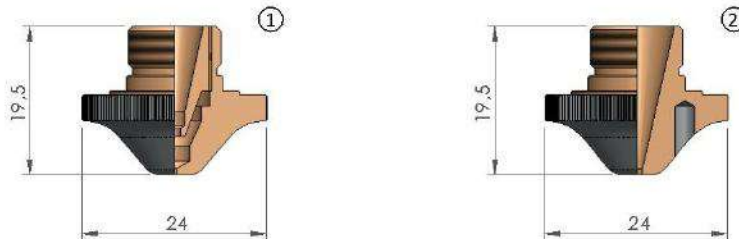

POS	LS. CODE	ORIGINAL CODE	DESCRIPTION
1	251022C	1059.70000.010	PRIMA I. [®] DOUBLE NOZZLE Ø 0.8 CP
	251022CW	1059.70000.010	PRIMA I. [®] DOUBLE NOZZLE Ø 0.8 CP
	251023C	1059.70000.003	PRIMA I. [®] DOUBLE NOZZLE Ø 1.0 CP
	251023CW	1059.70000.003	PRIMA I. [®] DOUBLE NOZZLE Ø 1.0 CP
	251024C	1059.70000.008	PRIMA I. [®] DOUBLE NOZZLE Ø 1.25 CP
	251024CW	1059.70000.008	PRIMA I. [®] DOUBLE NOZZLE Ø 1.25 CP
	251025C	1059.70000.004	PRIMA I. [®] DOUBLE NOZZLE Ø 1.5 CP
	251025CW	1059.70000.004	PRIMA I. [®] DOUBLE NOZZLE Ø 1.5 CP
	251026C	1059.70000.009	PRIMA I. [®] DOUBLE NOZZLE Ø 1.75 CP
	251026CW	1059.70000.009	PRIMA I. [®] DOUBLE NOZZLE Ø 1.75 CP
	251027C	1059.70000.005	PRIMA I. [®] DOUBLE NOZZLE Ø 2.0 CP
	251027CW	1059.70000.005	PRIMA I. [®] DOUBLE NOZZLE Ø 2.0 CP
	251028C	1059.70000.006	PRIMA I. [®] DOUBLE NOZZLE Ø 2.5 CP
	251028CW	1059.70000.006	PRIMA I. [®] DOUBLE NOZZLE Ø 2.5 CP
	251029C	1059.70000.007	PRIMA I. [®] DOUBLE NOZZLE Ø 3.0 CP
	251029CW	1059.70000.007	PRIMA I. [®] DOUBLE NOZZLE Ø 3.0 CP
2	253005C	LW6.1G.604	PRIMA I. [®] NOZZLE Ø 1.5 CP
	253005CW	LW6.1G.604	PRIMA I. [®] NOZZLE Ø 1.5 CP
	253006C		PRIMA I. [®] NOZZLE Ø 1.75 CP
	253006CW		PRIMA I. [®] NOZZLE Ø 1.75 CP
	253007C	LW6.1G.605	PRIMA I. [®] NOZZLE Ø 2.0 CP
	253007CW	LW6.1G.605	PRIMA I. [®] NOZZLE Ø 2.0 CP
	253008C	LW6.1G.606	PRIMA I. [®] NOZZLE Ø 2.5 CP
	253008CW	LW6.1G.606	PRIMA I. [®] NOZZLE Ø 2.5 CP
	253009C	LW6.1G.607	PRIMA I. [®] NOZZLE Ø 3.0 CP
253009CW	LW6.1G.607	PRIMA I. [®] NOZZLE Ø 3.0 CP	

Replacement parts suitable for PRIMA INDUSTRIE[®]

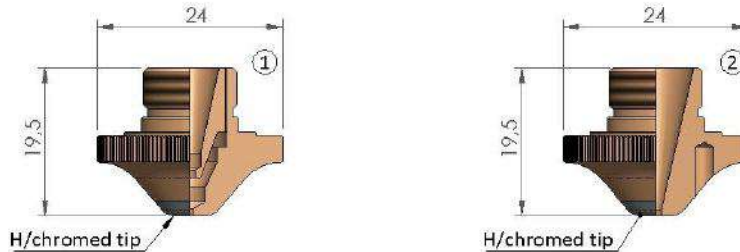

POS	LS. CODE	ORIGINAL CODE	DESCRIPTION
1	251022CK	1059.70000.010	PRIMA I. [®] DOUBLE NOZZLE Ø 0.8 CP
	251022CKW	1059.70000.010	PRIMA I. [®] DOUBLE NOZZLE Ø 0.8 CP
	251023CK	1059.70000.003	PRIMA I. [®] DOUBLE NOZZLE Ø 1.0 CP
	251023CKW	1059.70000.003	PRIMA I. [®] DOUBLE NOZZLE Ø 1.0 CP
	251024CK	1059.70000.008	PRIMA I. [®] DOUBLE NOZZLE Ø 1.25 CP
	251024CKW	1059.70000.008	PRIMA I. [®] DOUBLE NOZZLE Ø 1.25 CP
	251025CK	1059.70000.004	PRIMA I. [®] DOUBLE NOZZLE Ø 1.5 CP
	251025CKW	1059.70000.004	PRIMA I. [®] DOUBLE NOZZLE Ø 1.5 CP
	251026CK	1059.70000.009	PRIMA I. [®] DOUBLE NOZZLE Ø 1.75 CP
	251026CKW	1059.70000.009	PRIMA I. [®] DOUBLE NOZZLE Ø 1.75 CP
	251027CK	1059.70000.005	PRIMA I. [®] DOUBLE NOZZLE Ø 2.0 CP
	251027CKW	1059.70000.005	PRIMA I. [®] DOUBLE NOZZLE Ø 2.0 CP
	251028CK	1059.70000.006	PRIMA I. [®] DOUBLE NOZZLE Ø 2.5 CP
	251028CKW	1059.70000.006	PRIMA I. [®] DOUBLE NOZZLE Ø 2.5 CP
	251029CK	1059.70000.007	PRIMA I. [®] DOUBLE NOZZLE Ø 3.0 CP
251029CKW	1059.70000.007	PRIMA I. [®] DOUBLE NOZZLE Ø 3.0 CP	
2	253005CK	LW6.1G.604	PRIMA I. [®] NOZZLE Ø 1.5 CP
	253005CKW	LW6.1G.604	PRIMA I. [®] NOZZLE Ø 1.5 CP
	253006CK		PRIMA I. [®] NOZZLE Ø 1.75 CP
	253006CKW		PRIMA I. [®] NOZZLE Ø 1.75 CP
	253007CK	LW6.1G.605	PRIMA I. [®] NOZZLE Ø 2.0 CP
	253007CKW	LW6.1G.605	PRIMA I. [®] NOZZLE Ø 2.0 CP
	253008CK	LW6.1G.606	PRIMA I. [®] NOZZLE Ø 2.5 CP
	253008CKW	LW6.1G.606	PRIMA I. [®] NOZZLE Ø 2.5 CP
	253009CK	LW6.1G.607	PRIMA I. [®] NOZZLE Ø 3.0 CP
253009CKW	LW6.1G.607	PRIMA I. [®] NOZZLE Ø 3.0 CP	

Replacement parts suitable for PRIMA INDUSTRIE[®]

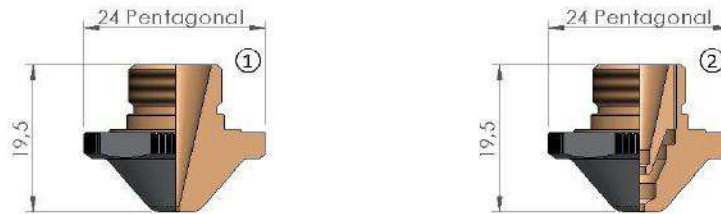

POS	LS. CODE	ORIGINAL CODE	DESCRIPTION
1	254003C	LW6.1G.633	PRIMA I. [®] NOZZLE PENT Ø 1.5 CP
	254003CW	LW6.1G.633	PRIMA I. [®] NOZZLE PENT Ø 1.5 CP
	254004C	LW6.1G.635	PRIMA I. [®] NOZZLE PENT Ø 2.0 CP
	254004CW	LW6.1G.635	PRIMA I. [®] NOZZLE PENT Ø 2.0 CP
	254005C	LW6.1G.637	PRIMA I. [®] NOZZLE PENT Ø 2.5 CP
	254005CW	LW6.1G.637	PRIMA I. [®] NOZZLE PENT Ø 2.5 CP
2	254013C	LW6.1G.643	PRIMA I. [®] DOUBLE NOZZLE PENT Ø 1.5 CP
	254013CW	LW6.1G.643	PRIMA I. [®] DOUBLE NOZZLE PENT Ø 1.5 CP
	254014C	LW6.1G.645	PRIMA I. [®] DOUBLE NOZZLE PENT Ø 2.0 CP
	254014CW	LW6.1G.645	PRIMA I. [®] DOUBLE NOZZLE PENT Ø 2.0 CP
	254015C	LW6.1G.647	PRIMA I. [®] DOUBLE NOZZLE PENT Ø 2.5 CP
	254015CW	LW6.1G.647	PRIMA I. [®] DOUBLE NOZZLE PENT Ø 2.5 CP

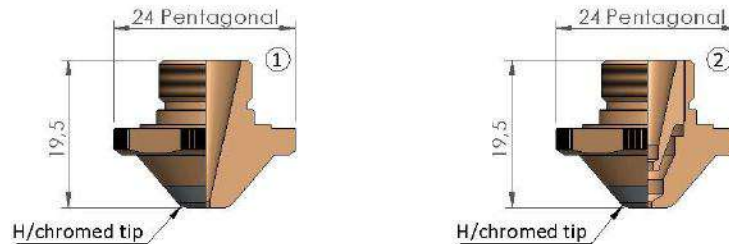

POS	LS. CODE	ORIGINAL CODE	DESCRIPTION
1	254003CK	LW6.1G.633	PRIMA I. [®] NOZZLE PENT Ø 1.5 CP
	254003CKW	LW6.1G.633	PRIMA I. [®] NOZZLE PENT Ø 1.5 CP
	254004CK	LW6.1G.635	PRIMA I. [®] NOZZLE PENT Ø 2.0 CP
	254004CKW	LW6.1G.635	PRIMA I. [®] NOZZLE PENT Ø 2.0 CP
	254005CK	LW6.1G.637	PRIMA I. [®] NOZZLE PENT Ø 2.5 CP
	254005CKW	LW6.1G.637	PRIMA I. [®] NOZZLE PENT Ø 2.5 CP
2	254013CK	LW6.1G.643	PRIMA I. [®] DOUBLE NOZZLE PENT Ø 1.5 CP
	254013CKW	LW6.1G.643	PRIMA I. [®] DOUBLE NOZZLE PENT Ø 1.5 CP
	254014CK	LW6.1G.645	PRIMA I. [®] DOUBLE NOZZLE PENT Ø 2.0 CP
	254014CKW	LW6.1G.645	PRIMA I. [®] DOUBLE NOZZLE PENT Ø 2.0 CP
	254015CK	LW6.1G.647	PRIMA I. [®] DOUBLE NOZZLE PENT Ø 2.5 CP
	254015CKW	LW6.1G.647	PRIMA I. [®] DOUBLE NOZZLE PENT Ø 2.5 CP

Replacement parts suitable for PRIMA INDUSTRIE[®]

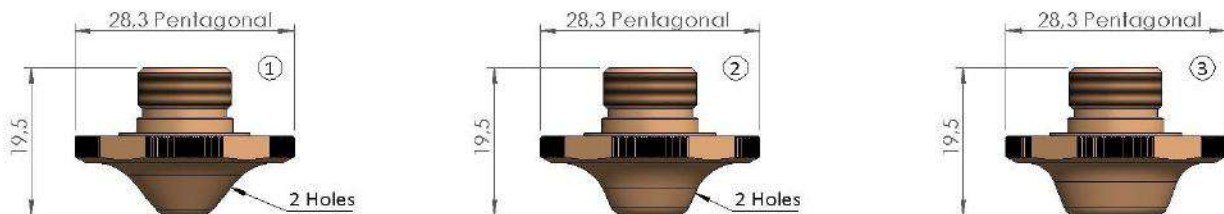

POS	LS. CODE	ORIGINAL CODE	DESCRIPTION
1	256001		PRIMA I. [®] DOUBLE NOZZLE PENT Ø 2.5 - SS
	256002		PRIMA I. [®] DOUBLE NOZZLE PENT Ø 3.0 - SS
	256003		PRIMA I. [®] DOUBLE NOZZLE PENT Ø 4.0 - SS
2	256004		PRIMA I. [®] DOUBLE NOZZLE PENT Ø 6.0 - SS
3	256005		PRIMA I. [®] DOUBLE NOZZLE PENT Ø 10.0 - SS

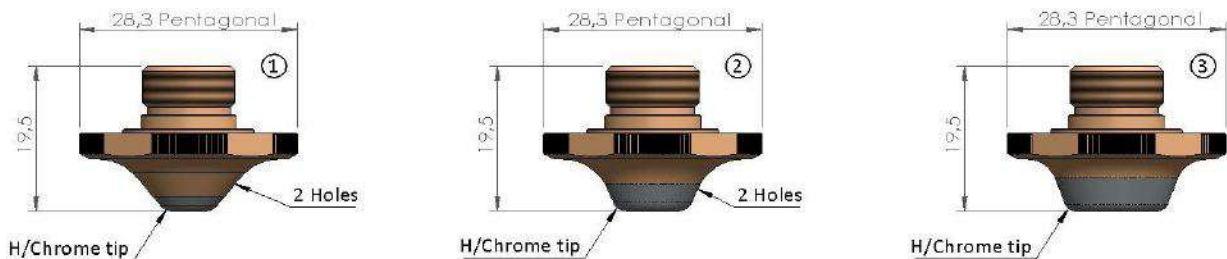

POS	LS. CODE	ORIGINAL CODE	DESCRIPTION
1	256001CK		PRIMA I. [®] DOUBLE NOZZLE PENT Ø 2.5 CP - SS
	256002CK		PRIMA I. [®] DOUBLE NOZZLE PENT Ø 3.0 CP - SS
	256003CK		PRIMA I. [®] DOUBLE NOZZLE PENT Ø 4.0 CP - SS
2	256004CK		PRIMA I. [®] DOUBLE NOZZLE PENT Ø 6.0 CP - SS
3	256005CK		PRIMA I. [®] DOUBLE NOZZLE PENT Ø 10.0 CP - SS

Replacement parts suitable for PRIMA INDUSTRIE[®]

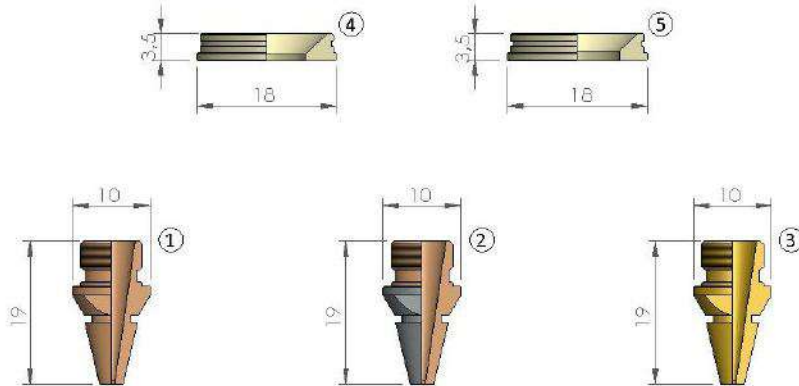

POS	LS. CODE	ORIGINAL CODE	DESCRIPTION
1	252011W		PRIMA I. [®] NOZZLE Ø 1.0 CONICAL
	252012W		PRIMA I. [®] NOZZLE Ø 1.2 CONICAL
	252013W		PRIMA I. [®] NOZZLE Ø 1.5 CONICAL
	252014W		PRIMA I. [®] NOZZLE Ø 1.7 CONICAL
	252015W		PRIMA I. [®] NOZZLE Ø 2.0 CONICAL
	252016W		PRIMA I. [®] NOZZLE Ø 2.5 CONICAL
	252017W		PRIMA I. [®] NOZZLE Ø 3.0 CONICAL
2	252011CW		PRIMA I. [®] NOZZLE Ø 1.0 CP
	252012CW		PRIMA I. [®] NOZZLE Ø 1.2 CP
	252013CW	485.73.431	PRIMA I. [®] NOZZLE Ø 1.5 CP
	252014CW		PRIMA I. [®] NOZZLE Ø 1.7 CP
	252015CW	485.73.433	PRIMA I. [®] NOZZLE Ø 2.0 CP
	252016CW		PRIMA I. [®] NOZZLE Ø 2.5 CP
	252017CW		PRIMA I. [®] NOZZLE Ø 3.0 CP
3	252043W	485.73.331	PRIMA I. [®] NOZZLE Ø 1.5 BRASS
	252045W	485.73.333	PRIMA I. [®] NOZZLE Ø 2.0 BRASS
	252046W	485.73.334	PRIMA I. [®] NOZZLE Ø 2.5 BRASS
4	259001	480.73.107	PRIMA I. [®] INSULATING RING-PLASTIC - HEAD 5" - ID 10"
5	259002		PRIMA I. [®] INSULATING RING-PLASTIC - HEAD 7.5" - ID 11"

Replacement parts suitable for PRIMA INDUSTRIE[®]

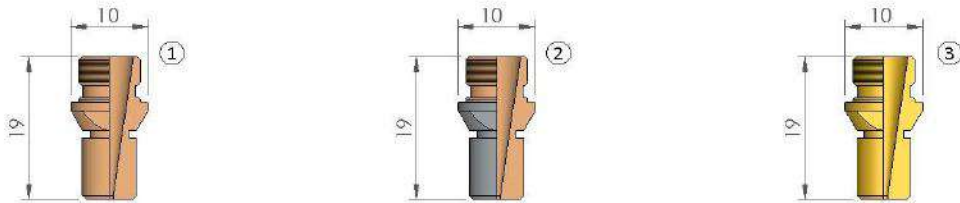

POS	LS. CODE	ORIGINAL CODE	DESCRIPTION
1	252001W		PRIMA I. [®] NOZZLE Ø 1.0
	252002W		PRIMA I. [®] NOZZLE Ø 1.2
	252003W		PRIMA I. [®] NOZZLE Ø 1.5
	252004W		PRIMA I. [®] NOZZLE Ø 1.7
	252005W		PRIMA I. [®] NOZZLE Ø 2.0
	252006W		PRIMA I. [®] NOZZLE Ø 2.5
	252007W		PRIMA I. [®] NOZZLE Ø 3.0
2	252001CW		PRIMA I. [®] NOZZLE Ø 1.0 CP
	252002CW		PRIMA I. [®] NOZZLE Ø 1.2 CP
	252003CW	485.73.421	PRIMA I. [®] NOZZLE Ø 1.5 CP
	252004CW		PRIMA I. [®] NOZZLE Ø 1.7 CP
	252005CW	485.73.422	PRIMA I. [®] NOZZLE Ø 2.0 CP
	252006CW	485.73.423	PRIMA I. [®] NOZZLE Ø 2.5 CP
	252007CW	485.73.424	PRIMA I. [®] NOZZLE Ø 3.0 CP
3	252031W		PRIMA I. [®] NOZZLE Ø 1.0 BRASS
	252033W	485.73.321	PRIMA I. [®] NOZZLE Ø 1.5 BRASS
	252035W	485.73.322	PRIMA I. [®] NOZZLE Ø 2.0 BRASS
	252036W	485.73.323	PRIMA I. [®] NOZZLE Ø 2.5 BRASS
	252037W	485.73.324	PRIMA I. [®] NOZZLE Ø 3.0 BRASS

Replacement parts suitable for PRIMA INDUSTRIE[®]

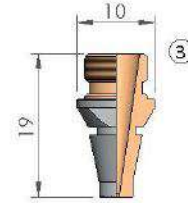
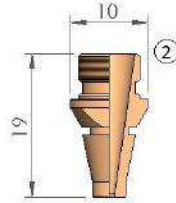
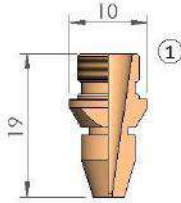

POS	LS. CODE	ORIGINAL CODE	DESCRIPTION
1	252061W		PRIMA I. [®] NOZZLE Ø 1.0
	252062W		PRIMA I. [®] NOZZLE Ø 1.2
	252063W		PRIMA I. [®] NOZZLE Ø 1.5
	252064W		PRIMA I. [®] NOZZLE Ø 1.7
	252065W		PRIMA I. [®] NOZZLE Ø 2.0
	252066W		PRIMA I. [®] NOZZLE Ø 2.5
	252067W		PRIMA I. [®] NOZZLE Ø 3.0
2	252023W		PRIMA I. [®] NOZZLE Ø 1.5
	252024W		PRIMA I. [®] NOZZLE Ø 2.0
	252025W		PRIMA I. [®] NOZZLE Ø 2.5
	252026W		PRIMA I. [®] NOZZLE Ø 3.0
3	252023CW	485.73.451	PRIMA I. [®] NOZZLE Ø 1.5 CP
	252024CW	485.73.452	PRIMA I. [®] NOZZLE Ø 2.0 CP
	252025CW	485.73.453	PRIMA I. [®] NOZZLE Ø 2.5 CP
	252026CW		PRIMA I. [®] NOZZLE Ø 3.0 CP

Replacement parts suitable for PRIMA INDUSTRIE[®]

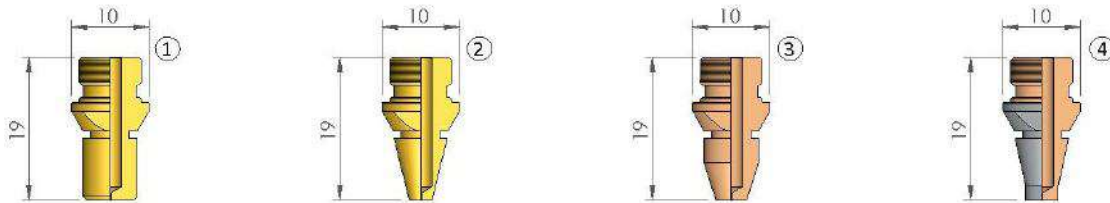

POS	LS. CODE	ORIGINAL CODE	DESCRIPTION
1	252070W	490.76.102	PRIMA I. [®] NOZZLE Ø 0.3 BRASS
2	252071W	490.76.103	PRIMA I. [®] NOZZLE Ø 0.3 BRASS
3	252072W		PRIMA I. [®] NOZZLE Ø 0.3
4	252073CW	485.73.455	PRIMA I. [®] NOZZLE Ø 0.3 CP

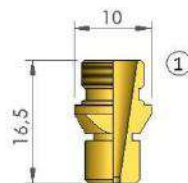

POS	LS. CODE	ORIGINAL CODE	DESCRIPTION
1	252051W	490.1N.301	PRIMA I. [®] NOZZLE Ø 2.0 BRASS
	252052W	490.1N.302	PRIMA I. [®] NOZZLE Ø 2.5 BRASS
	252053W		PRIMA I. [®] NOZZLE Ø 3.0 BRASS

Replacement parts suitable for PRIMA INDUSTRIE[®]

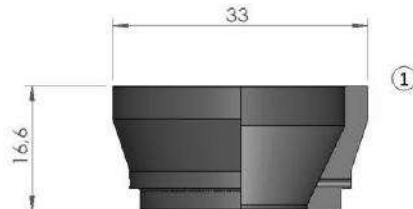

POS	LS. CODE	ORIGINAL CODE	DESCRIPTION
1	259010	LW6.59.121	PRIMA I. [®] SENSOR INSULTAOR



POS	LS. CODE	ORIGINAL CODE	DESCRIPTION
1	259015	820.63.150	PRIMA INDUSTRIE [®] SENSOR CABLE 150 MM COMPATIBLE
	259016	756.63.923	PRIMA INDUSTRIE [®] SENSOR CABLE 230 MM COMPATIBLE
	259017	523.P6.935	PRIMA INDUSTRIE [®] SENSOR CABLE 350 MM COMPATIBLE

POS	LS. CODE	ORIGINAL CODE	DESCRIPTION
	259020	1058.36520.720	PRIMA I. [®] LENS GASKET